

SR120 THRU SR1100

List

深圳FMS Kinter 131 6803 0058

List.....	1
Package outline.....	2
Features.....	2
Mechanical data.....	2
Maximum ratings	2
Rating and characteristic curves.....	3
Pinning information.....	4
Marking.....	4
Taping & bulk specifications for AXIAL devices.....	4
Suggested thermal profiles for soldering processes.....	5
High reliability test capabilities.....	6

SR120 THRU SR1100

1.0A Axial Leaded Schottky Barrier Rectifiers - 20V-100V

Features

- Axial lead type devices for through hole design.
- Low power loss, high efficiency.
- High current capability, low forward voltage drop.
- High surge capability.
- Guardring for overvoltage protection.
- Ultra high-speed switching.
- Silicon epitaxial planar chip, metal silicon junction.
- Lead-free parts meet environmental standards of MIL-STD-19500 /228
- Suffix "-H" indicates Halogen free parts, ex. SR120-H.

Mechanical data

- Epoxy : UL94-V0 rated flame retardant
- Case : Molded plastic, DO-41
- Lead : Axial leads, solderable per MIL-STD-202, Method 208 guaranteed
- Polarity: Color band denotes cathode end
- Mounting Position : Any
- Weight : Approximated 0.33 gram

Package outline

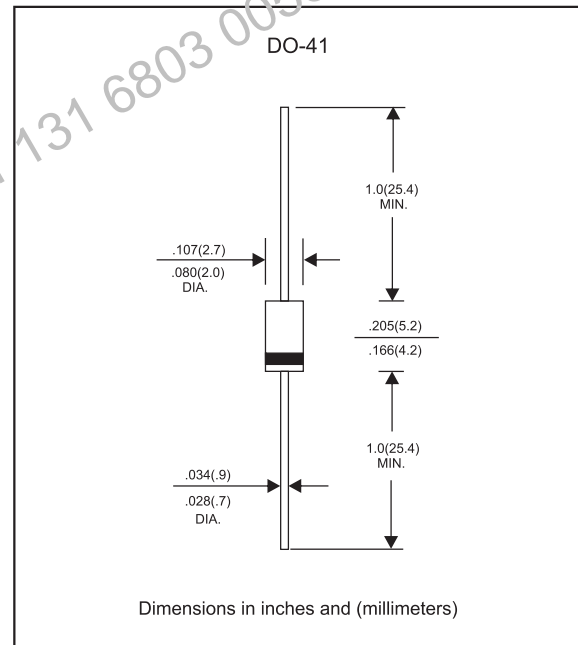

Maximum ratings and Electrical Characteristics (AT $T_A=25^\circ\text{C}$ unless otherwise noted)

PARAMETER	CONDITIONS	Symbol	MIN.	TYP.	MAX.	UNIT
Forward rectified current	See Fig.2	I_O			1.0	A
Forward surge current	8.3ms single half sine-wave superimposed on rate load (JEDEC methode)	I_{FSM}			30	A
Reverse current	$V_R = V_{RRM} \quad T_J = 25^\circ\text{C}$	I_R			0.5	mA
	$V_R = V_{RRM} \quad T_J = 100^\circ\text{C}$				10	
Thermal resistance	Junction to ambient	$R_{\theta JA}$		50		$^\circ\text{C}/\text{W}$
Diode junction capacitance	f=1MHz and applied 4V DC reverse voltage	C_J		110		pF
Storage temperature		T_{STG}	-65		+175	$^\circ\text{C}$

SYMBOLS	V_{RRM}^{*1} (V)	V_{RMS}^{*2} (V)	V_R^{*3} (V)	V_F^{*4} (V)	Operating temperature $T_J, (^\circ\text{C})$
SR120	20	14	20	0.55	-55 to +125
SR130	30	21	30		
SR140	40	28	40		
SR150	50	35	50	0.70	-55 to +150
SR160	60	42	60		
SR180	80	56	80	0.85	
SR1100	100	70	100		

*1 Repetitive peak reverse voltage

*2 RMS voltage

*3 Continuous reverse voltage

*4 Maximum forward voltage@ $I_F=1.0\text{A}$

Rating and characteristic curves (SR120 THRU SR1100)

FIG.1-TYPICAL FORWARD CURRENT DERATING CURVE

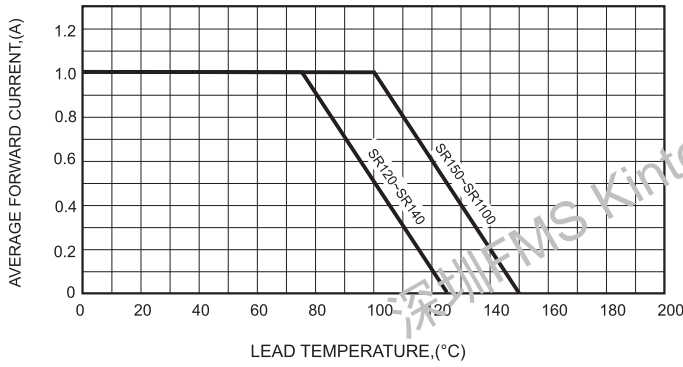

FIG.2-TYPICAL FORWARD CHARACTERISTICS

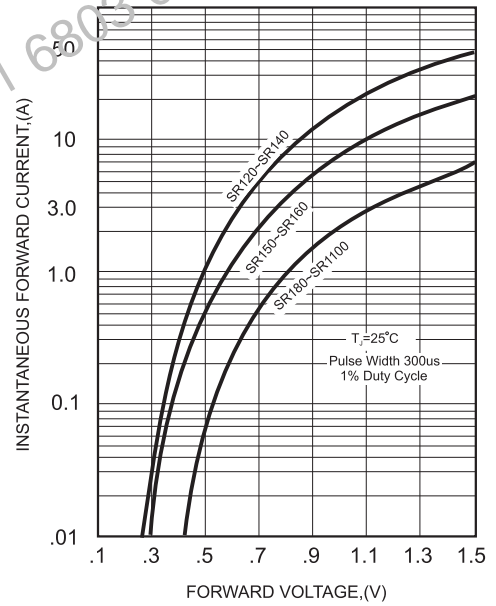

FIG.3-MAXIMUM NON-REPETITIVE FORWARD SURGE CURRENT

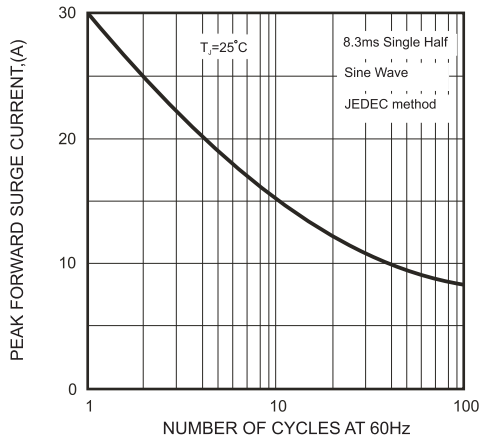

FIG.4-TYPICAL JUNCTION CAPACITANCE

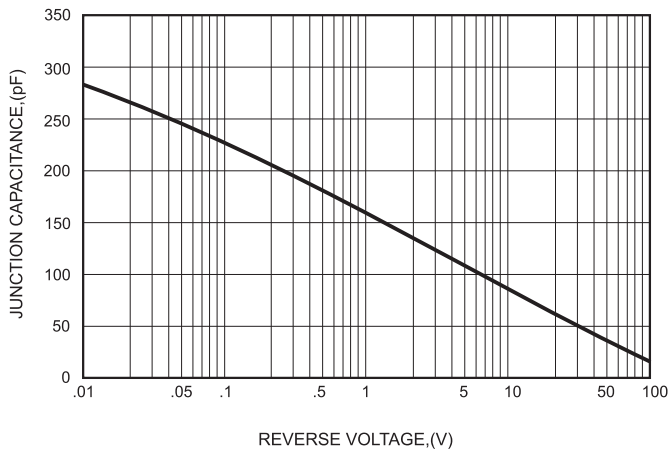
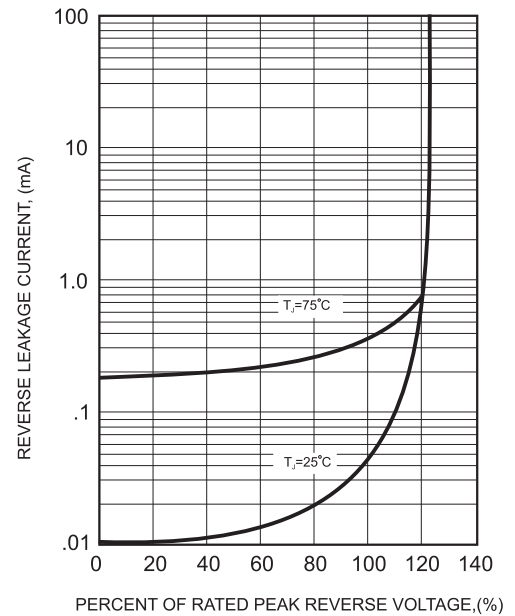



FIG.5 - TYPICAL REVERSE CHARACTERISTICS



SR120 THRU SR1100

Pinning information

Pin	Simplified outline	Symbol
Pin1 cathode Pin2 anode		

Marking

Type number	Marking code
SR120	SR120
SR130	SR130
SR140	SR140
SR150	SR150
SR160	SR160
SR180	SR180
SR1100	SR1100

Taping & bulk specifications for AXIAL devices

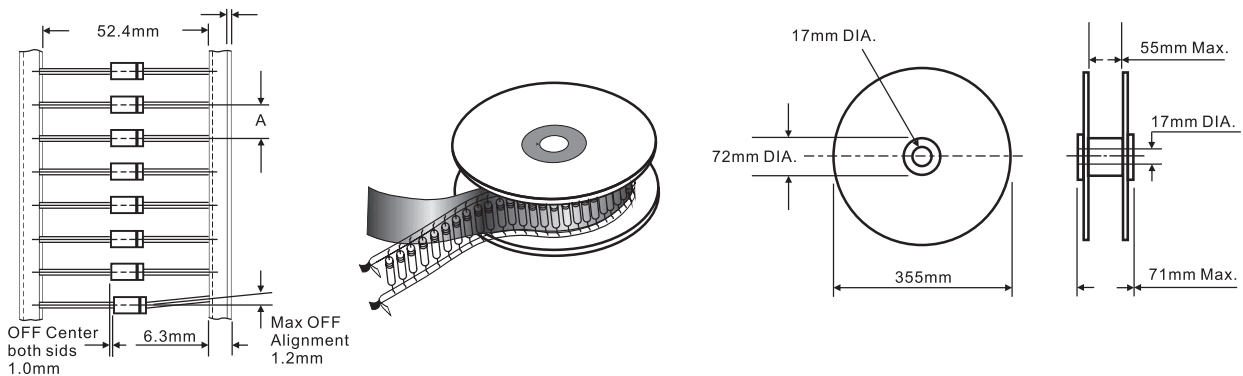

REEL PACKING

DEVICE CASE TYPE	Q'TY 1 (PCS / REEL)	COMPONENT SPACING "A" in FIG. A	CARTON SIZE (m/m)	Q'TY 2 (PCS / CARTON)	APPROX. CROSS WEIGHT(kg)
DO-41	5,000	5 mm	360 * 340 * 370	20,000	10.8

AMMO PACKING

DEVICE CASE TYPE	Q'TY 1 (PCS / BOX)	INNER BOX SIZE (m/m)	CARTON SIZE (m/m)	Q'TY 2 (PCS / CARTON)	APPROX. CROSS WEIGHT(kg)
DO-41	5,000	260 * 83 * 160	440 * 270 * 340	50,000	20.0

SR120 THRU SR1100

BULK PACKING

DEVICE CASE TYPE	Q'TY 1 (PCS / BOX)	INNER BOX SIZE (m/m)	CARTON SIZE (m/m)	Q'TY 2 (PCS / CARTON)	APPROX. CROSS WEIGHT(kg)
DO-41	1,000	194 * 84 * 20	465 * 220 * 260	50,000	20.6

Suggested thermal profiles for soldering processes

1. Lead free temperature profile wave-soldering

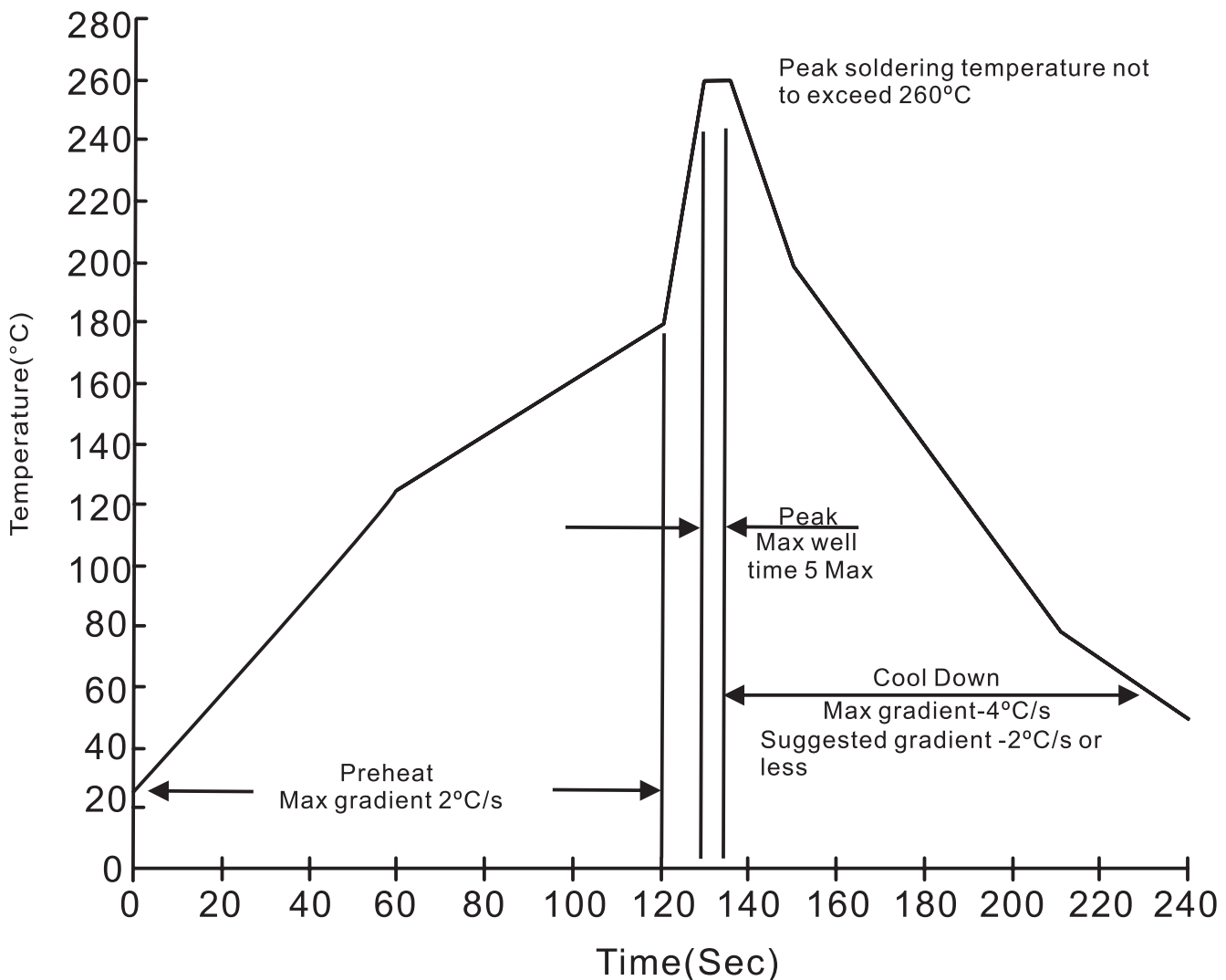

SR120 THRU SR1100

High reliability test capabilities

Item Test	Conditions	Reference
1. Solder Resistance	at 260±5°C for 10±2sec. immerse body into solder 1/16"±1/32"	MIL-STD-750D METHOD-2031
2. Solderability	at 245±5°C for 5 sec.	MIL-STD-202F METHOD-208
3. Pull Test	1.0kg in axial lead direction for 10 sec.	MIL-STD-750D METHOD-2036
4. Bend Lead	1.0kg weight applied to each lead bending arc 90°±5° for 3 times.	MIL-STD-750D METHOD-2036
5. High Temperature Reverse Bias	V _R =80% rate at T _J =125°C for 168 hrs.	MIL-STD-750D METHOD-1038
6. Forward Operation Life	Rated average rectifier current at T _A =25°C for 500hrs.	MIL-STD-750D METHOD-1027
7. Intermittent Operation Life	T _A = 25°C, I _F = I _O On state: power on for 5 min. off state: power off for 5 min, on and off for 500 cycles.	MIL-STD-750D METHOD-1036
8. Pressure Cooker	15P _{SIG} at T _A =121°C for 4 hrs.	JESD22-A102
9. Temperature Cycling	-55°C to +125°C dwelled for 30 min. and transferred for 5min. total 10 cycles.	MIL-STD-750D METHOD-1051
10. Thermal Shock	0°C for 5 min. rise to 100°C for 5 min. total 10 cycles.	MIL-STD-750D METHOD-1056
11. Forward Surge	8.3ms single half sine-wave superimposed on rated load, one surge.	MIL-STD-750D METHOD-4066-2
12. Humidity	at T _A =85°C, RH=85% for 1000hrs.	MIL-STD-750D METHOD-1021
13. High Temperature Storage Life	at 175°C for 1000 hrs.	MIL-STD-750D METHOD-1031